

# TARGHA GH-ST standard







IP54

Colour: Greyhound grey GH

The entry panel from **Bpt** merges the utmost modularity and functionality with the most advanced aesthetic values contemporary design has to offer. Just a few codes is all it takes to find the right solution for any need. Made from anodized aluminium and available in two colours, Anthracite grey ST and light Greyhound grey GH, the Targha entry panel's high-tech appearance blends in effortlessly with the style of any building. Easy to install, Targha is particularly suitable wherever leaving the existing structures untouched is of paramount importance.



Page reference for product codes		
SYSTEMS	 X1 2-wire	Page 81
	 300 on Bus	Page 137
	 200 Multi-wire	Page 174

 EMBEDDING BOX DIMENSIONS  
90x198x51.5 mm

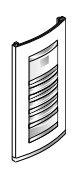
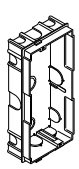

 FRONT PLATE DIMENSIONS  
99x207x28 mm

## FUNCTIONS

Directional surveillance camera with easy adjustment of the monitoring angle (+/- 11° both horizontally and vertically)

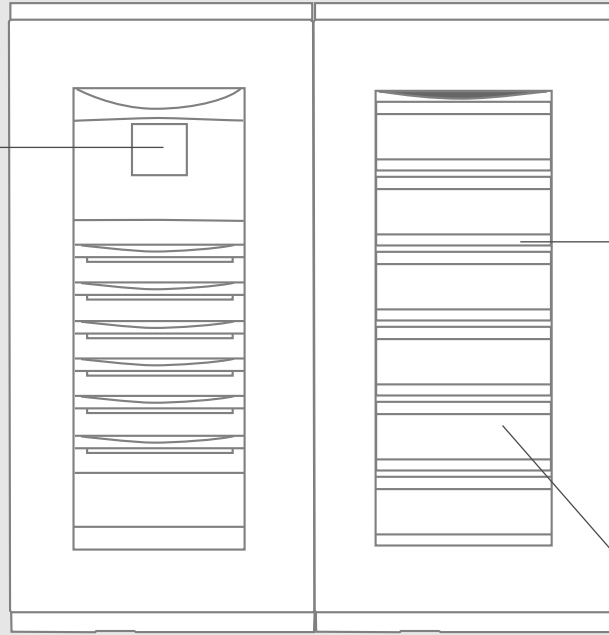

Minimum thickness (28 mm)



Up to twelve buttons thanks to the twin keys



LED backlighting

## TYPES OF PRODUCTS AVAILABLE

### Video entry panel

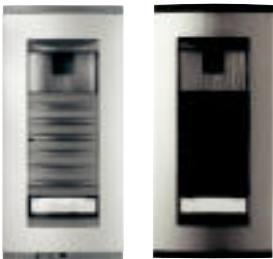

Greyhound grey GH

Anthracite grey ST

### Audio entry panel



Greyhound grey GH

Anthracite grey ST

### 6-buttons entry panel

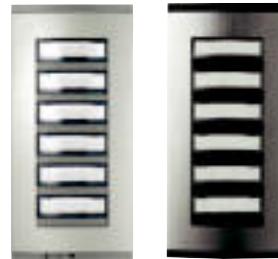

Greyhound grey GH

Anthracite grey ST

### 12-buttons entry panel

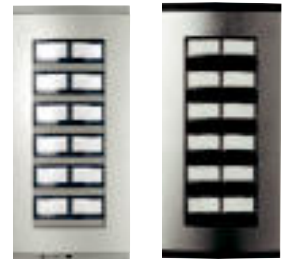

Greyhound grey GH

Anthracite grey ST

## VERTICAL-HORIZONTAL COMPOSITION

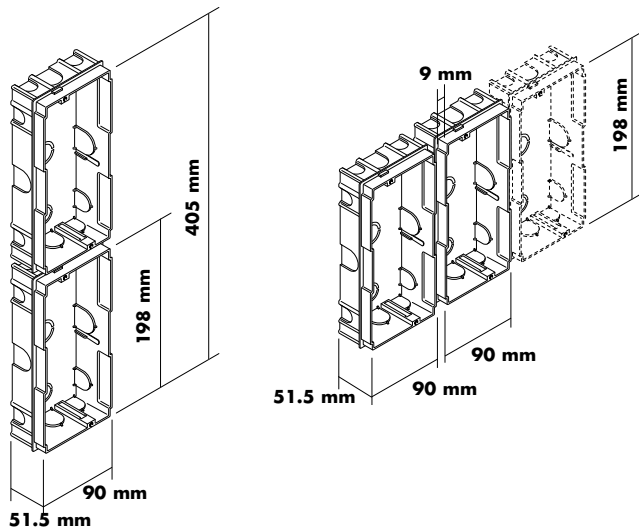

## ADDITIONAL BUTTON KITS

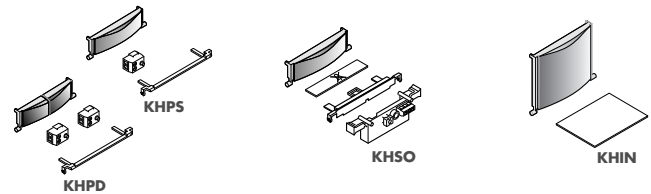

Kits KHPS and KHPD enable single or twin keys to be added to the front plates shown above. The KHSO kit is used to add the busy warning, and the KHIN kit lets you enter additional information (e.g. flat number, business hours etc.).

## BLANK KEY COVER

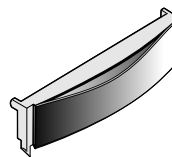

Standard issue with the six or twelve buttons front plate.



Embedding boxes feature cable-routing spacers for correct positioning during installation.

# TARGHA GH-ST standard digital



IP54

Colour: Greyhound grey GH

Unbeatable performance in the smallest package: thanks to the digital push button panel, even building complexes with a large number of users will no longer be a problem. The electronic coded call entry panels are the best solution, in terms of both practicality of use as well as guaranteed privacy. Targha is equipped with backlit keys and a generously sized display. It can be recessed or wall-mounted and is available in two colours, Anthracite grey ST and light Greyhound grey GH.



SYSTEMS	Page reference for product codes		
		2-wire	Page 85
		on Bus	Page 141
		Multi-wire	Page 178

EMBEDDING BOX DIMENSIONS:  
HTS GH and HTS GR  
90x198x51.5 mm

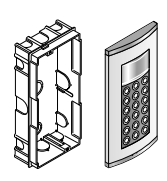

FRONT PLATE DIMENSIONS:  
GH-ST 99x207x28 mm  
VR 99x207x27 mm

## FUNCTIONS

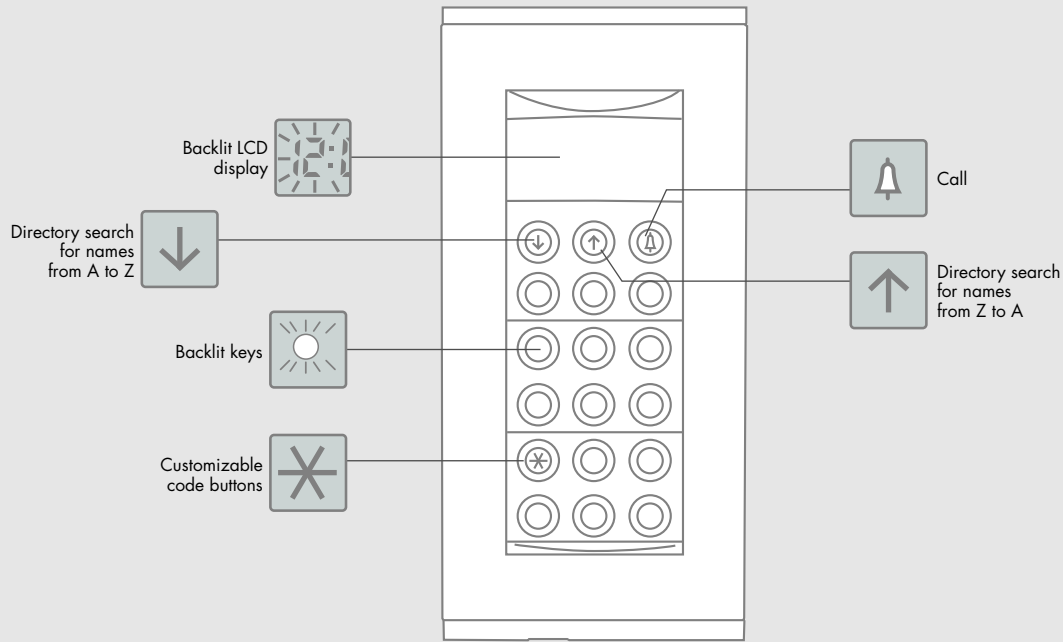

## TYPES OF PRODUCTS AVAILABLE

### Alphanumeric digital front plate



Greyhound  
grey GH

Anthracite  
grey ST

## VERTICAL-HORIZONTAL COMPOSITION

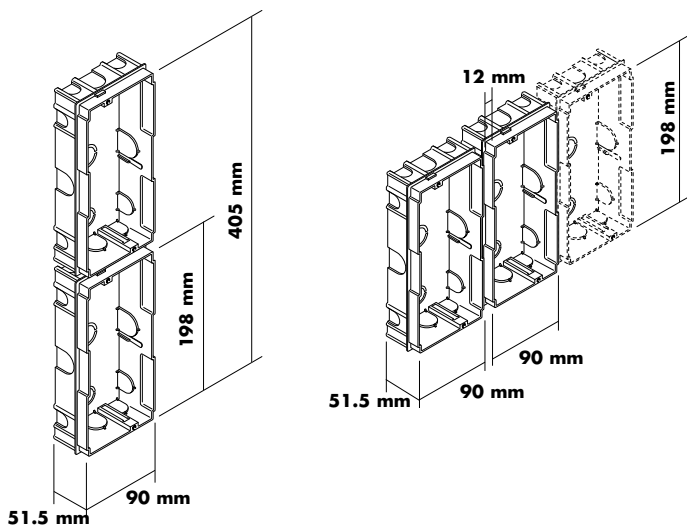

## WALL-MOUNTED OR RECESSED INSTALLATION

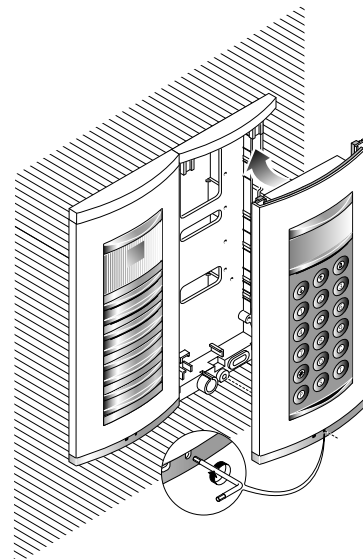

Embedding boxes feature cable-routing spacers for correct positioning during installation.